

REV.	DESCRIPTION	DATE	CHECKED
A	NEW RELEASE	04.15.2014	NICOLE

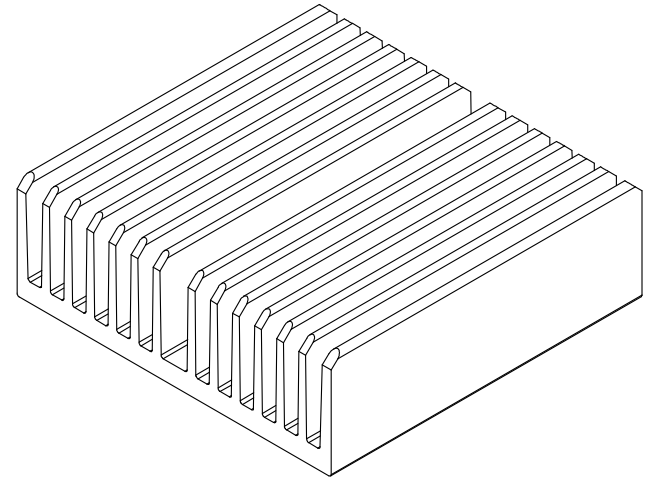
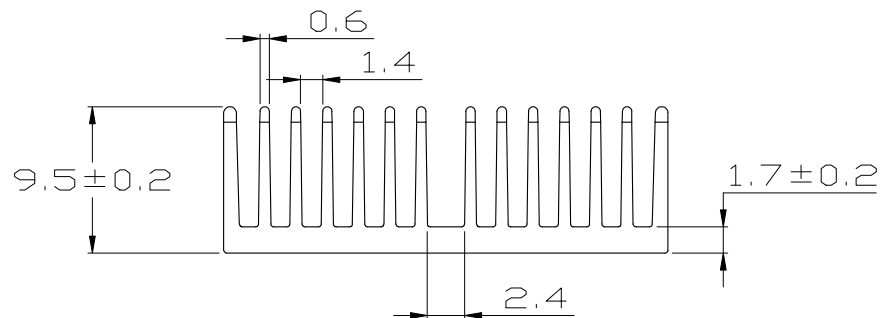
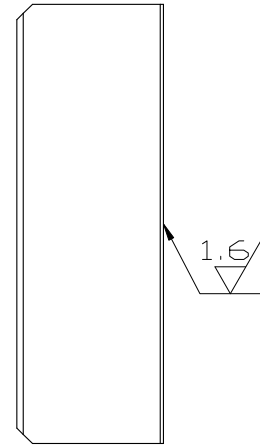
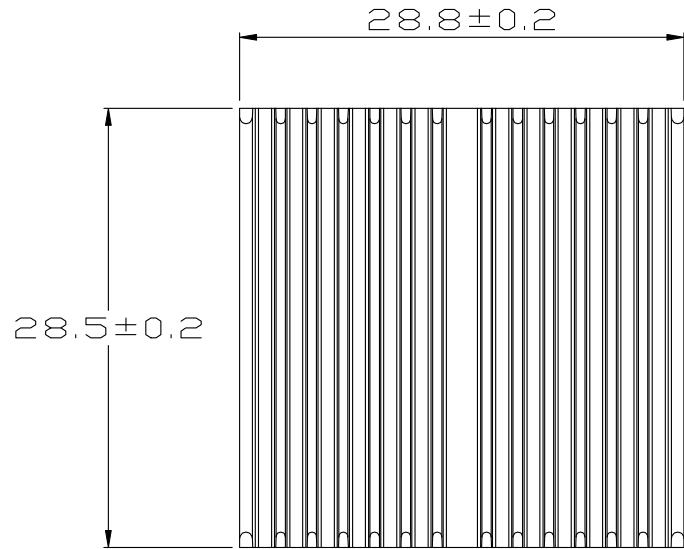

UNIT:	MM
TOLERANCE TABLE	
X.	± 0.30
X.X	± 0.20
X.XX	± 0.10
ANGLE	$\pm 1^\circ$

FINISH:	BLACK ANODIZE			
MATERIAL:	AL 6063			
DATE:	APPROVED:	CHECKED:	DRAWN:	REV.:
04.15.2014	AUDI	WEN	NICOLE	A
TITLE:	P/N :			
HEAT SINK	H 29-10			