

REV.	DESCRIPTION	DATE	CHECKED
A	NEW RELEASE	03.20.2014	LUCY

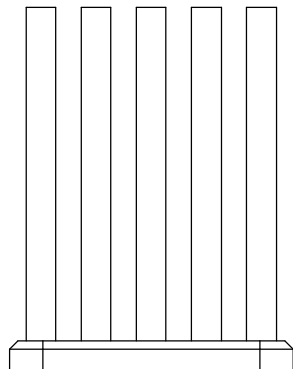
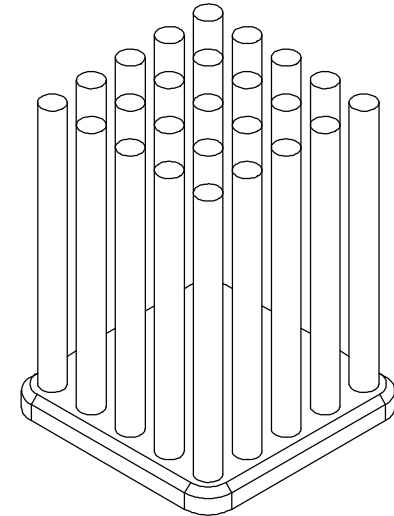
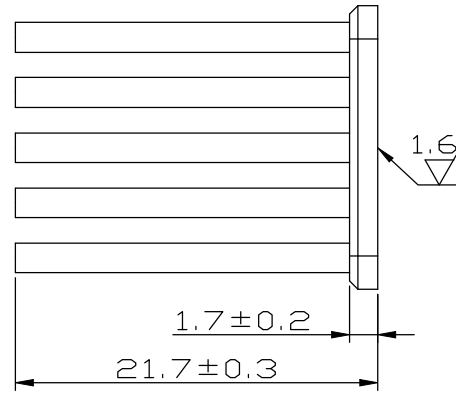
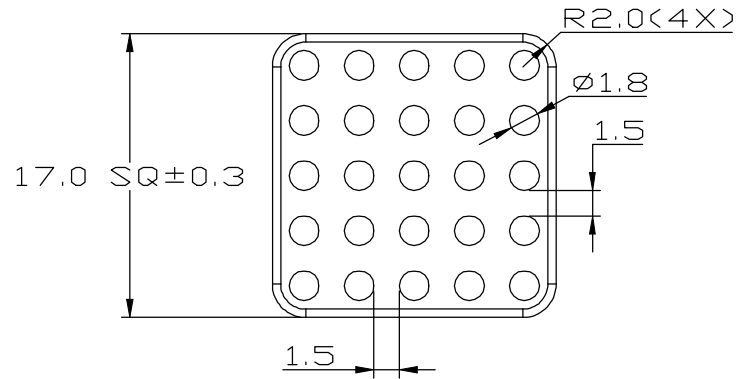

UNIT:	MM
TOLERANCE TABLE	
X.	±0.30
X.X	±0.20
X.XX	±0.10
ANGLE	±1°

FINISH: BLACK ANODIZE		ENZOTECH			
MATERIAL: AL 6063					
DATE: 03.20.2014	APPROVED: AUDI	CHECKED: NICOLE	DRAWN: LUCY	REV.: A	P/N. : MP 17-22
TITLE: HEAT SINK					