

REV.	DESCRIPTION	DATE	CHECKED
A	NEW RELEASE	03.20.2014	LUCY

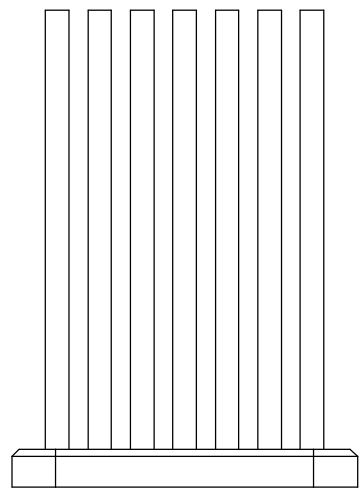
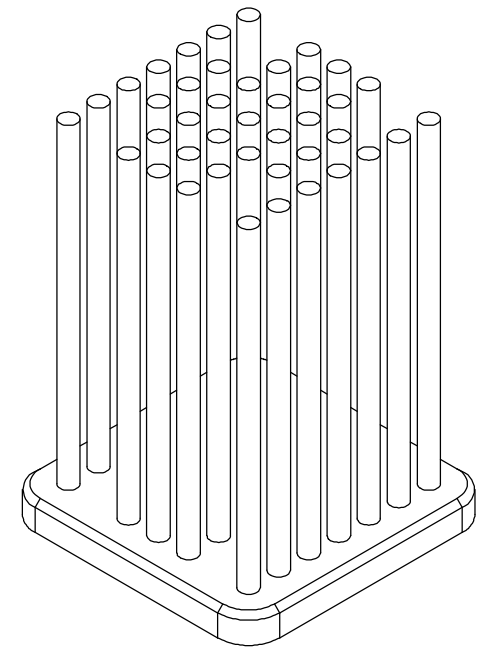
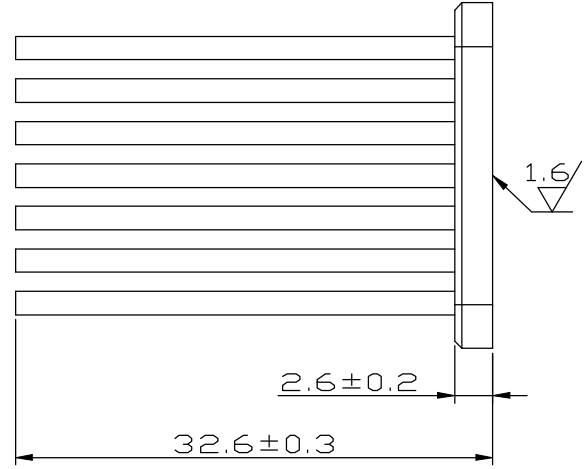
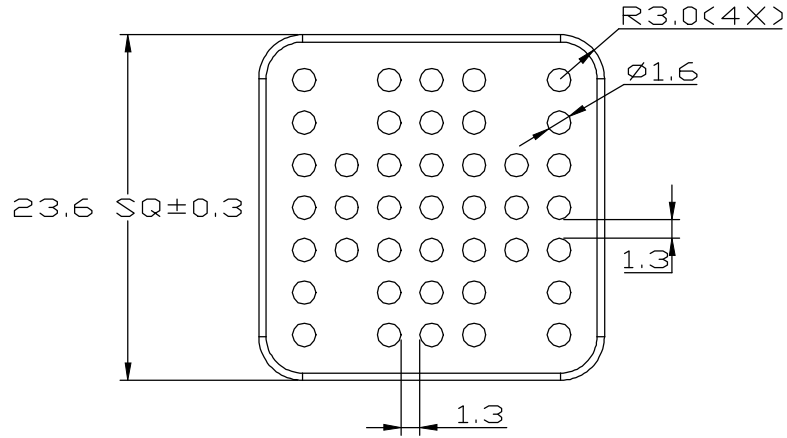

UNIT:	MM
TOLERANCE TABLE	
X.	=±0.30
X.X	=±0.20
X.XX	=±0.10
ANGLE	=±1°

FINISH:	BLACK ANODIZE			
MATERIAL:	AL 6063			
DATE:	APPROVED:	CHECKED:	DRAWN:	REV.:
03.20.2014	AUDI	NICOLE	LUCY	A
TITLE:	P/N :			
HEAT SINK	MP 24-33			

A
B
C
D
E
F

A
B
C
D
E
F

1 2 3 4 5 6 7 8 9 10

1 2 3 4 5 6 7 8 9 10