

REV.	DESCRIPTION	DATE	CHECKED
A	NEW RELEASE	04.21.2014	NICOLE

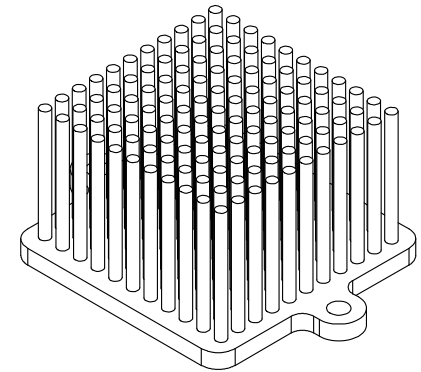
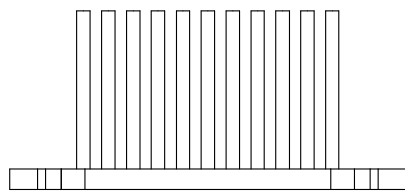
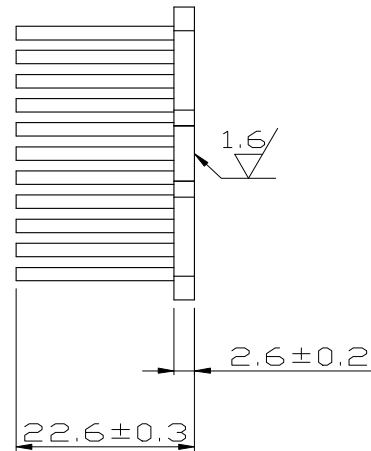
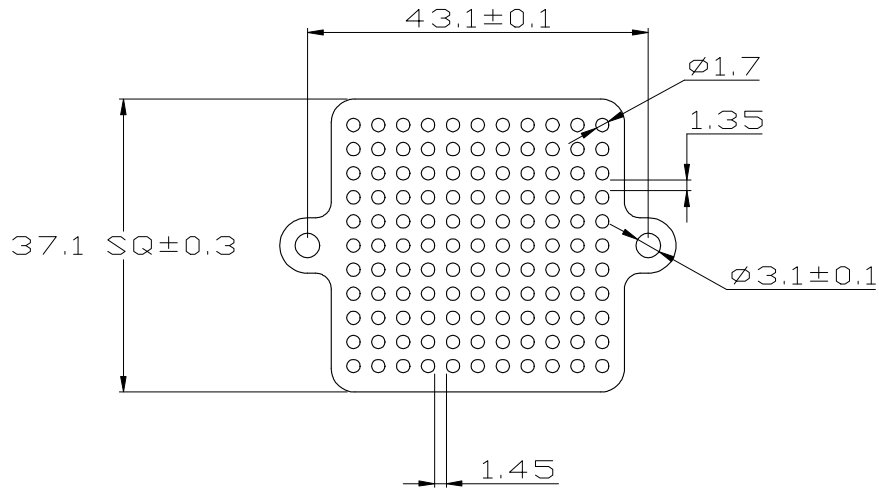

UNIT:	MM
TOLERANCE TABLE	
X.	=±0.30
X.X	=±0.20
X.XX	=±0.10
ANGLE	=±1°

FINISH: BLACK ANODIZE		<b>ENZOTECH</b>			
MATERIAL: AL 6063					
DATE: 04.21.2014	APPROVED: AUDI	CHECKED: WEN	DRAWN: NICOLE	REV.: A	P/N : <b>MPWM 37.5-23</b>
TITLE: HEAT SINK					