

REV.	DESCRIPTION	DATE	CHECKED
A	NEW RELEASE	03.18.2014	LUCY

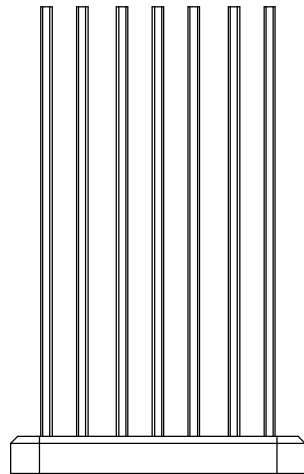
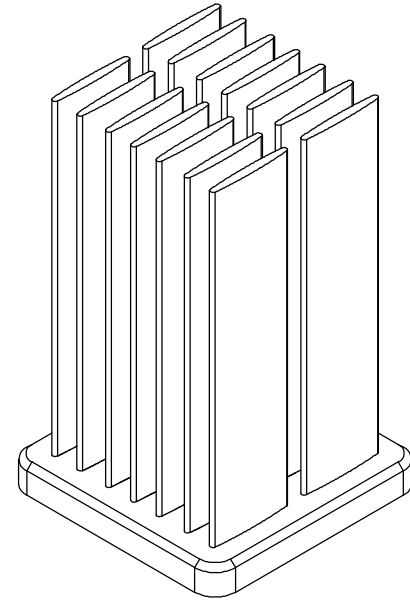
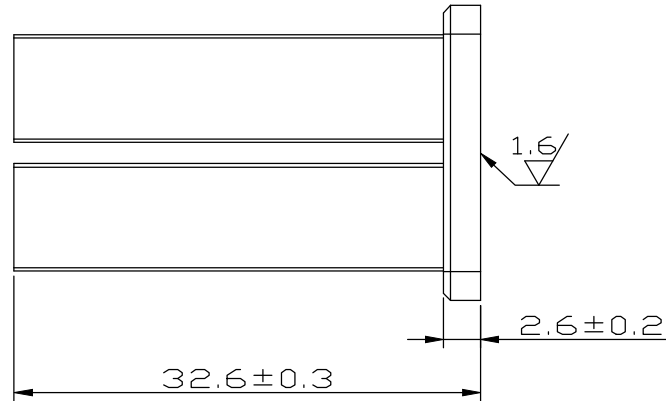
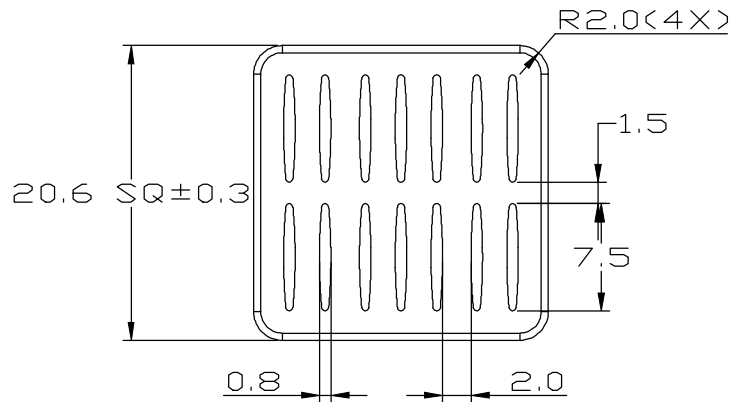

UNIT:	MM
TOLERANCE TABLE	
X.	±0.30
X.X	±0.20
X.XX	±0.10
ANGLE	±1°

FINISH:	BLACK ANODIZE			
MATERIAL:	AL 6063			
DATE:	APPROVED:	CHECKED:	DRAWN:	REV.:
03.18.2014	AUDI	NICOLE	LUCY	A
TITLE:	P/N. :			
HEAT SINK	MW 21-33			

ENZOTECH