

REV.	DESCRIPTION	DATE	CHECKED
A	NEW RELEASE	03.19.2014	LUCY

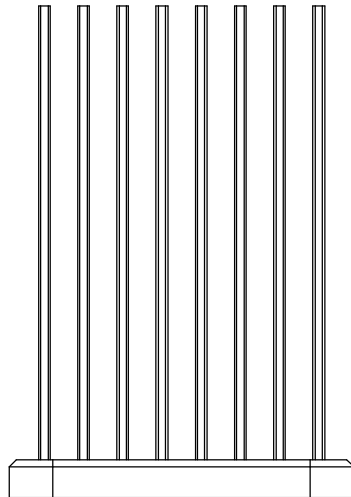
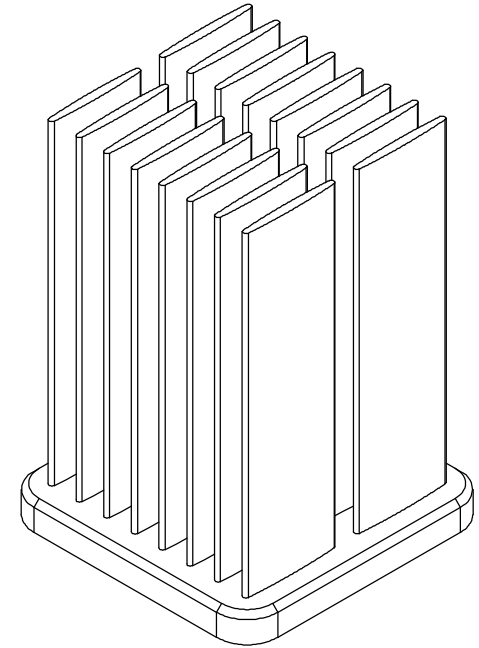
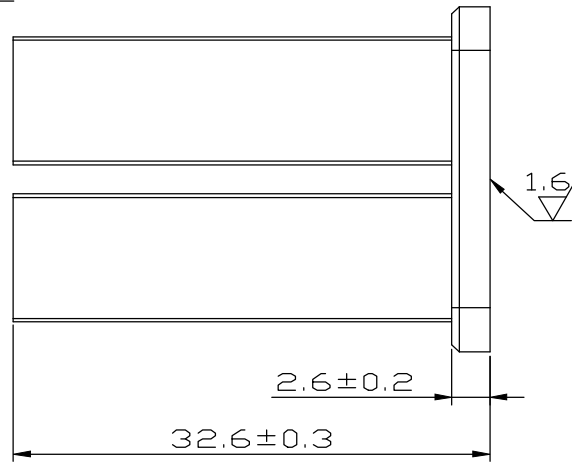
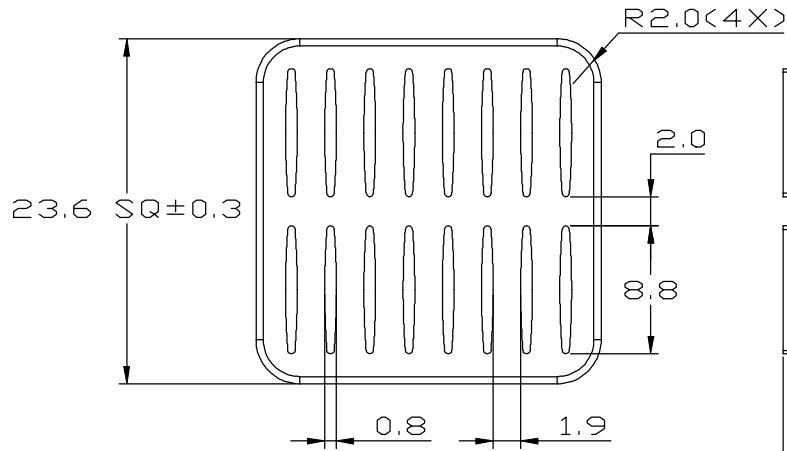

UNIT:	MM
TOLERANCE TABLE	
X.	=±0.30
X.X	=±0.20
X.XX	=±0.10
ANGLE	=±1°

FINISH: BLACK ANODIZE					
MATERIAL: AL 6063					
DATE: 03.19.2014		APPROVED: AUDI	CHECKED: NICOLE	DRAWN: LUCY	REV.: A
TITLE: HEAT SINK		P/N. : MW 24-33			