

REV.	DESCRIPTION	DATE	CHECKED
A	NEW RELEASE	03.19.2014	LUCY

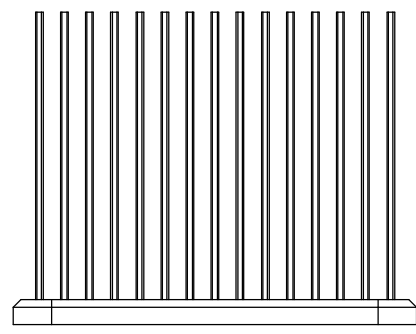
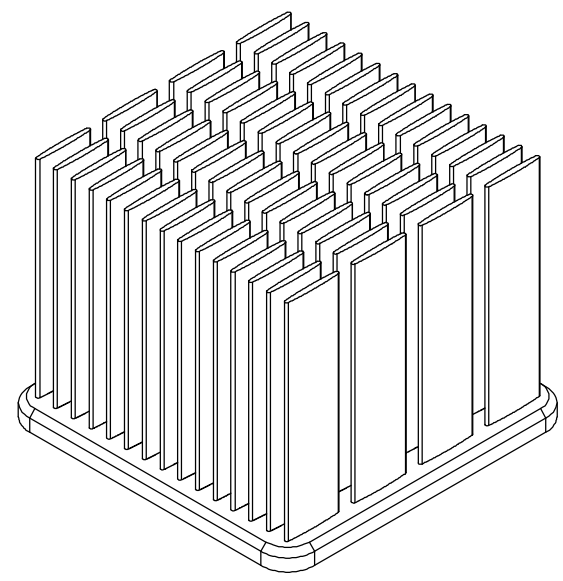
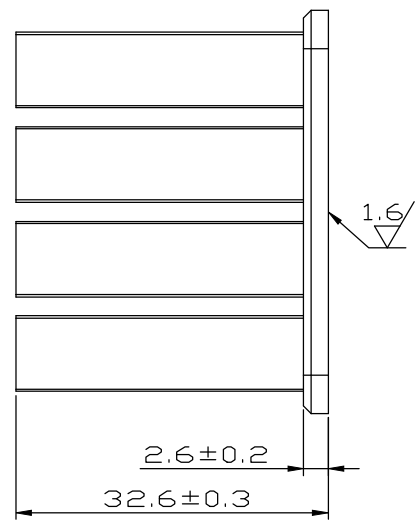
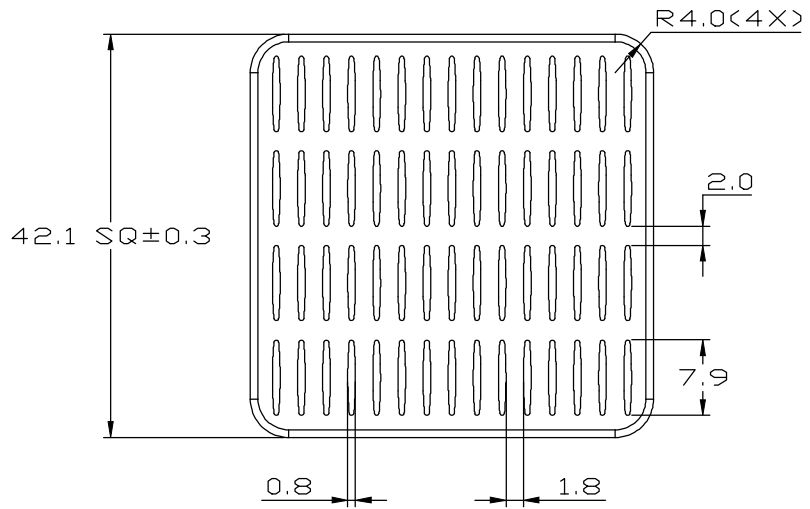

UNIT:	MM
TOLERANCE TABLE	
X.	±0.30
X.X	±0.20
X.XX	±0.10
ANGLE	±1°

FINISH: BLACK ANODIZE					ENZOTECH
MATERIAL: AL 6063					
DATE: 03.19.2014	APPROVED: AUDI	CHECKED: NICOLE	DRAWN: LUCY	REV.: A	P/N : MW 42.5-33
TITLE: HEAT SINK					