

REV.	DESCRIPTION	DATE	CHECKED
A	NEW RELEASE	06.16.2015	LUCY

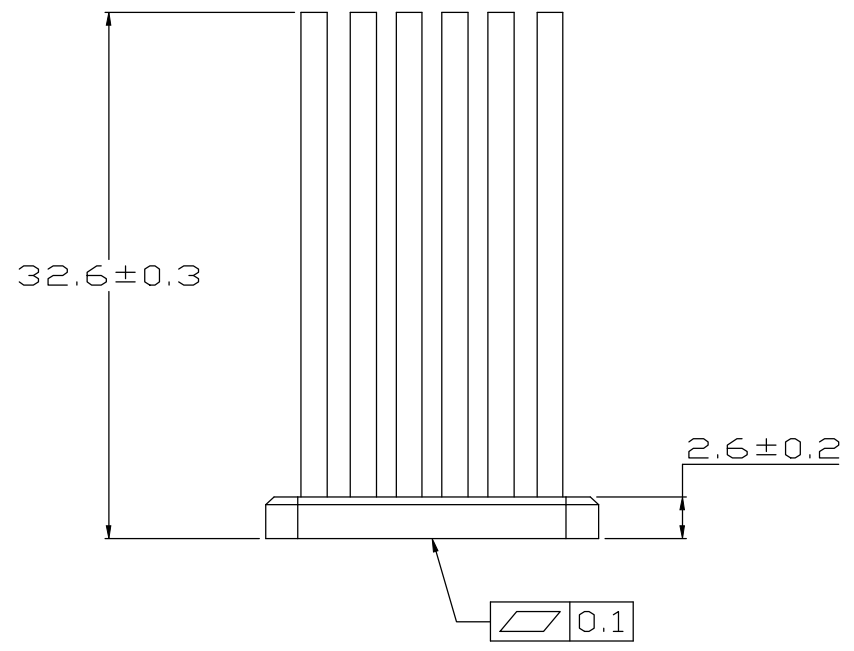
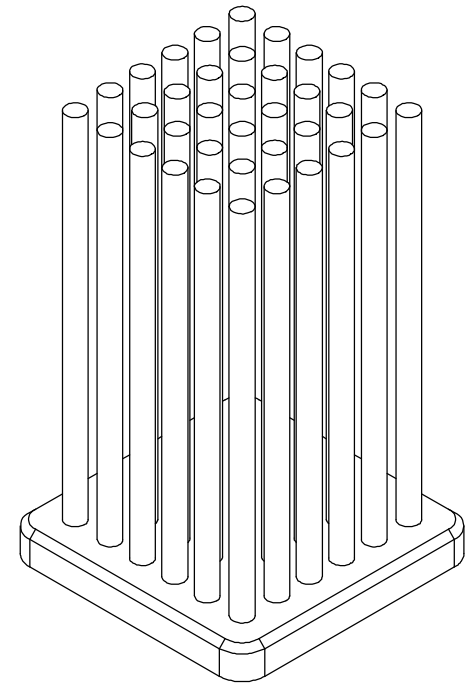
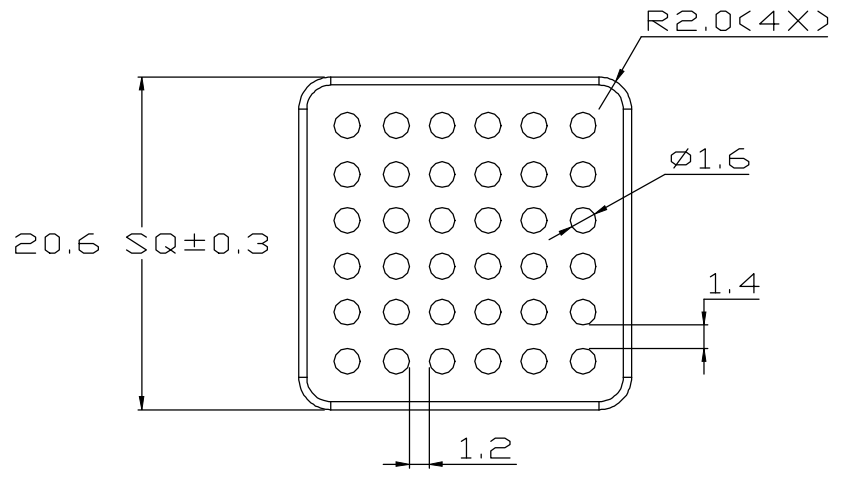

UNIT:	MM
TOLERANCE TABLE	
X.	=±0.30
X.X	=±0.20
X.XX	=±0.10
ANGLE	=±1°

FINISH:	NATURAL ANODIZE			
MATERIAL:	AL 6063			
DATE:	APPROVED:	CHECKED:	DRAWN:	REV.:
06.16.2015	AUDI	WEN	LUCY	A
TITLE:	P/N.:			
HEAT SINK	Uni-H21052-33P/2.6			

A  
B  
C  
D  
E  
F

A  
B  
C  
D  
E  
F

1 2 3 4 5 6 7 8 9 10

1 2 3 4 5 6 7 8 9 10

A2