

REV.	DESCRIPTION	DATE	CHECKED
A	NEW RELEASE	06.17.2015	LUCY

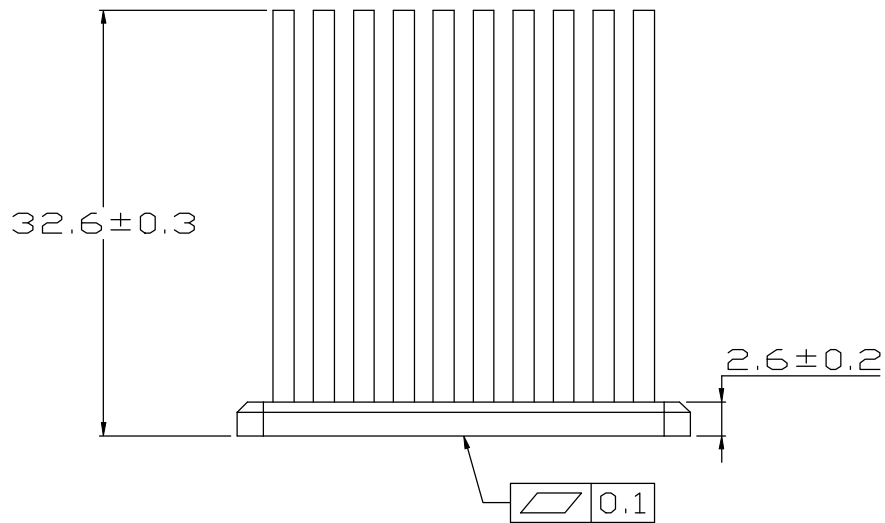
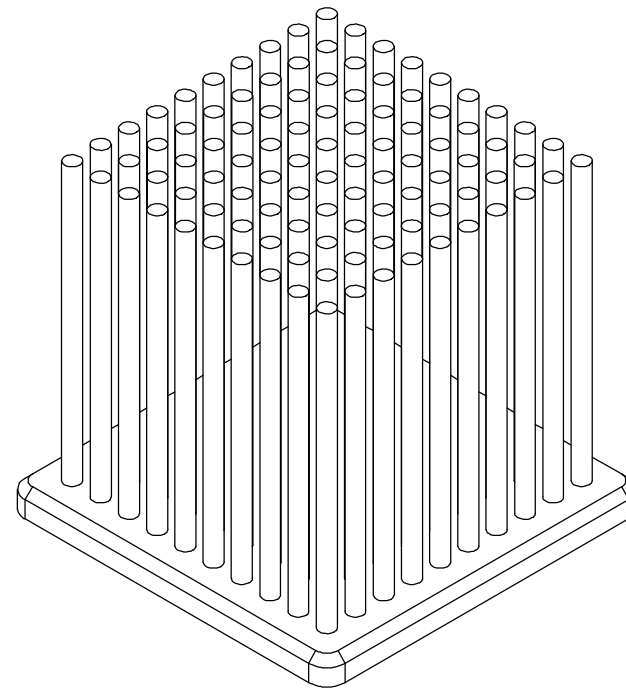
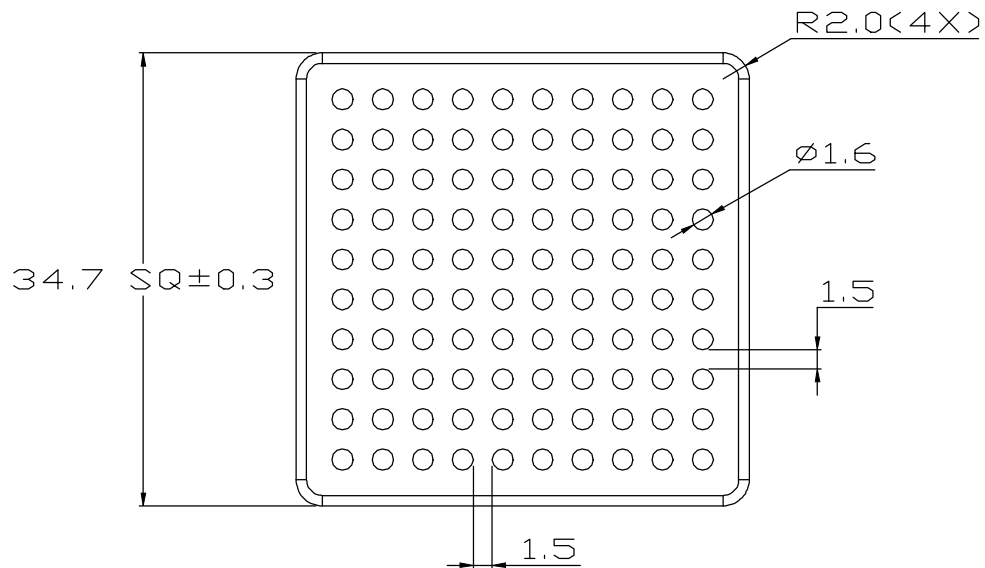

UNIT:	MM
TOLERANCE TABLE	
X.	=±0.30
X.X	=±0.20
X.XX	=±0.10
ANGLE	=±1°

FINISH: NATURAL ANODIZE		ENZOTECH			
MATERIAL: AL 6063					
DATE: 06.17.2015	APPROVED: AUDI	CHECKED: WEN	DRAWN: LUCY	REV.: A	P/N : Uni-H35052-33P/2.6
TITLE: HEAT SINK					