

REV.	DESCRIPTION	DATE	CHECKED
A	NEW RELEASE	06.16.2015	LUCY

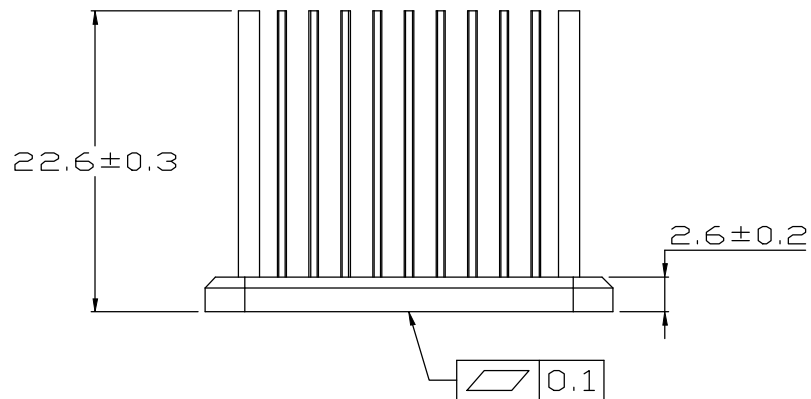
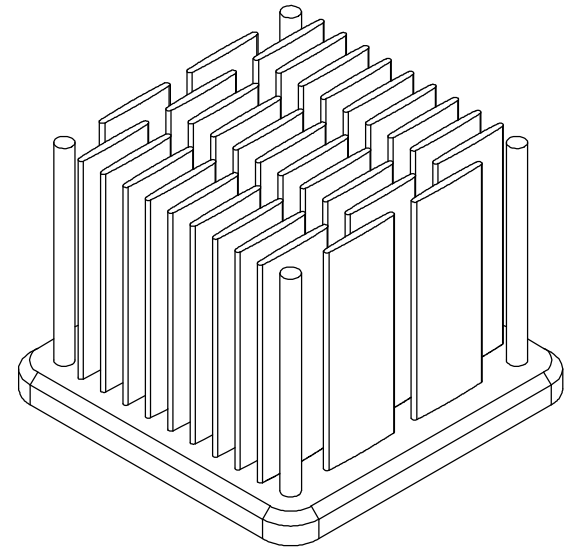
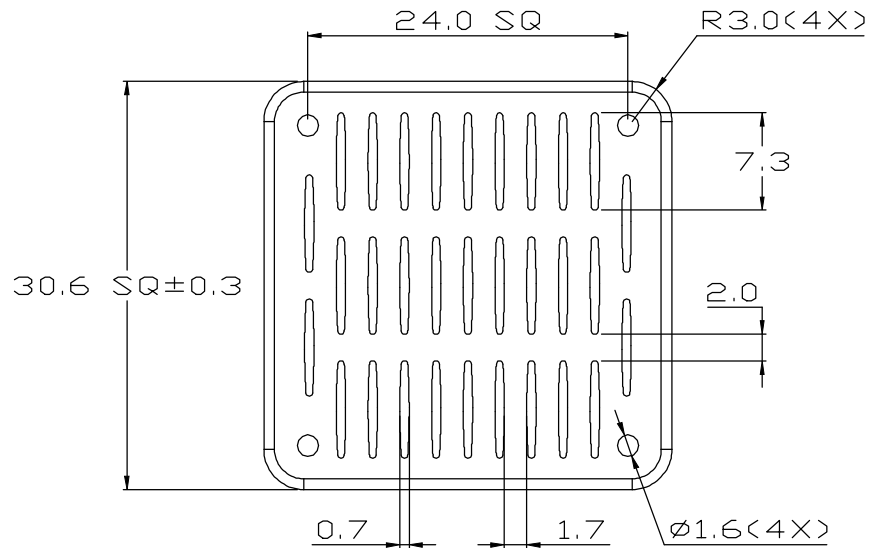

UNIT:	MM
TOLERANCE TABLE	
X.	±0.30
X.X	±0.20
X.XX	±0.10
ANGLE	±1°

FINISH:	NATURAL ANODIZE			
MATERIAL:	AL 6063			
DATE:	APPROVED:	CHECKED:	DRAWN:	REV.:
06.16.2015	AUDI	WEN	LUCY	A
TITLE:	P/N :			
HEAT SINK	Uni-H31051-23W/2.6			

A

B

C

D

E

F

A

B

C

D

E

F

A2